

**GENERAL NOTES**

- All work contemplated herein shall be done in conformity with approved specifications for Standard Specifications for Highway Construction, 1974 Edition, as amended, and the Standard Specifications for Highway Construction, 1974 Edition, as amended, and the Standard Specifications for Highway Construction, 1974 Edition, as amended.
- The contractor shall be responsible for obtaining all necessary permits and for obtaining all necessary approvals from the appropriate authorities.
- The contractor shall be responsible for obtaining all necessary permits and for obtaining all necessary approvals from the appropriate authorities.
- Remove all existing signs and markings on the site and replace with new signs and markings as shown on the drawings.
- Remove all existing signs and markings on the site and replace with new signs and markings as shown on the drawings.

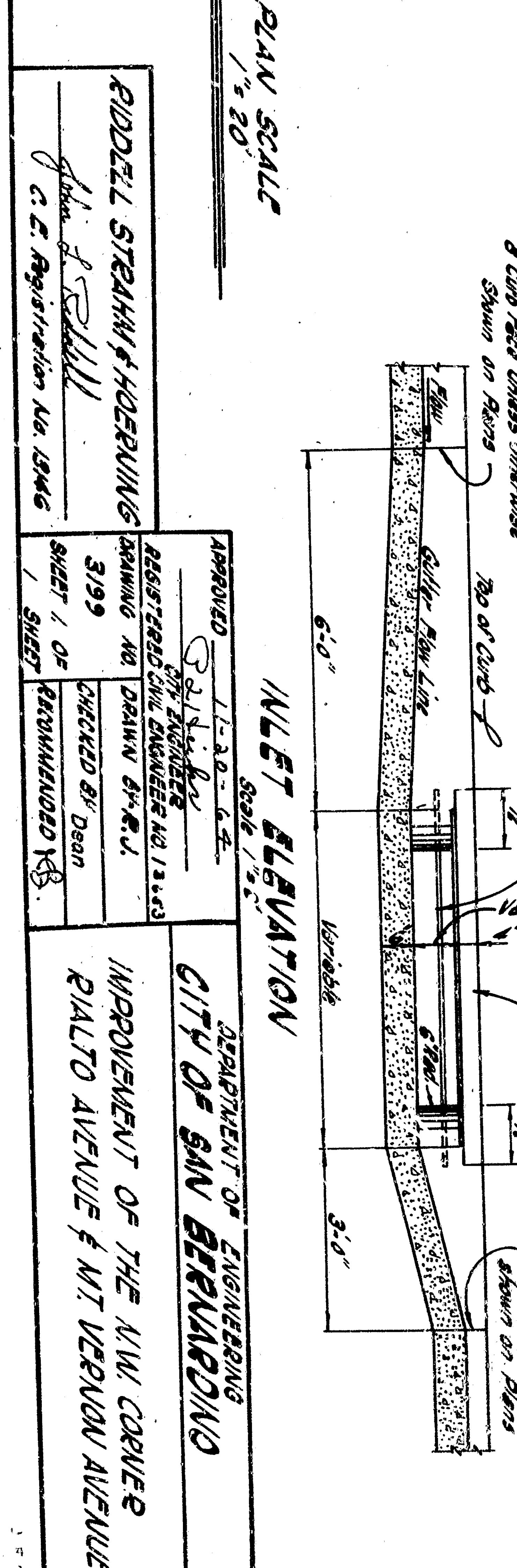
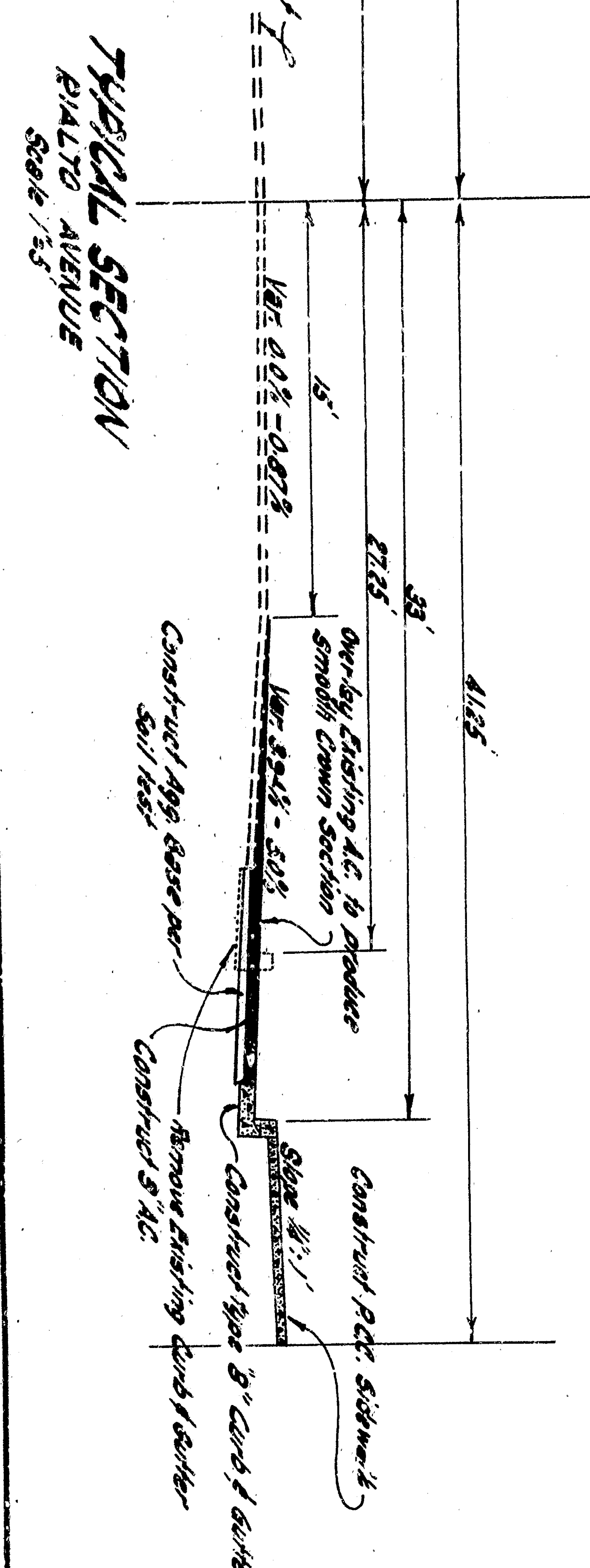
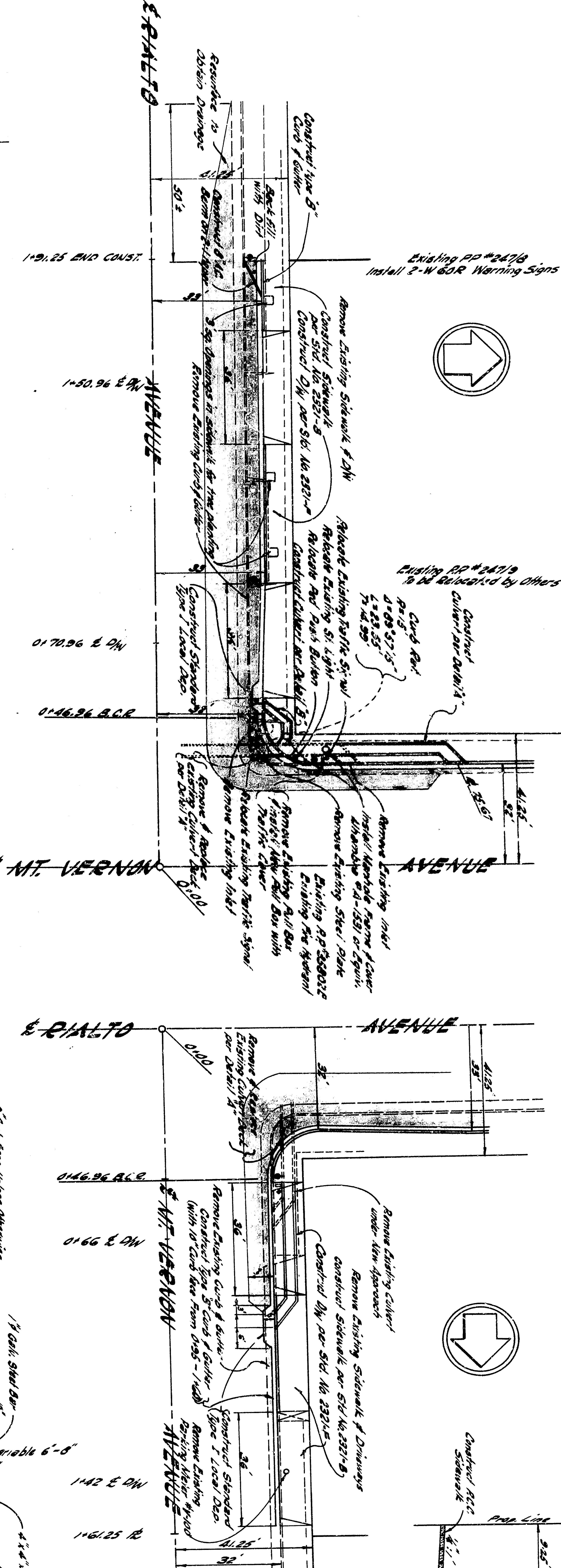
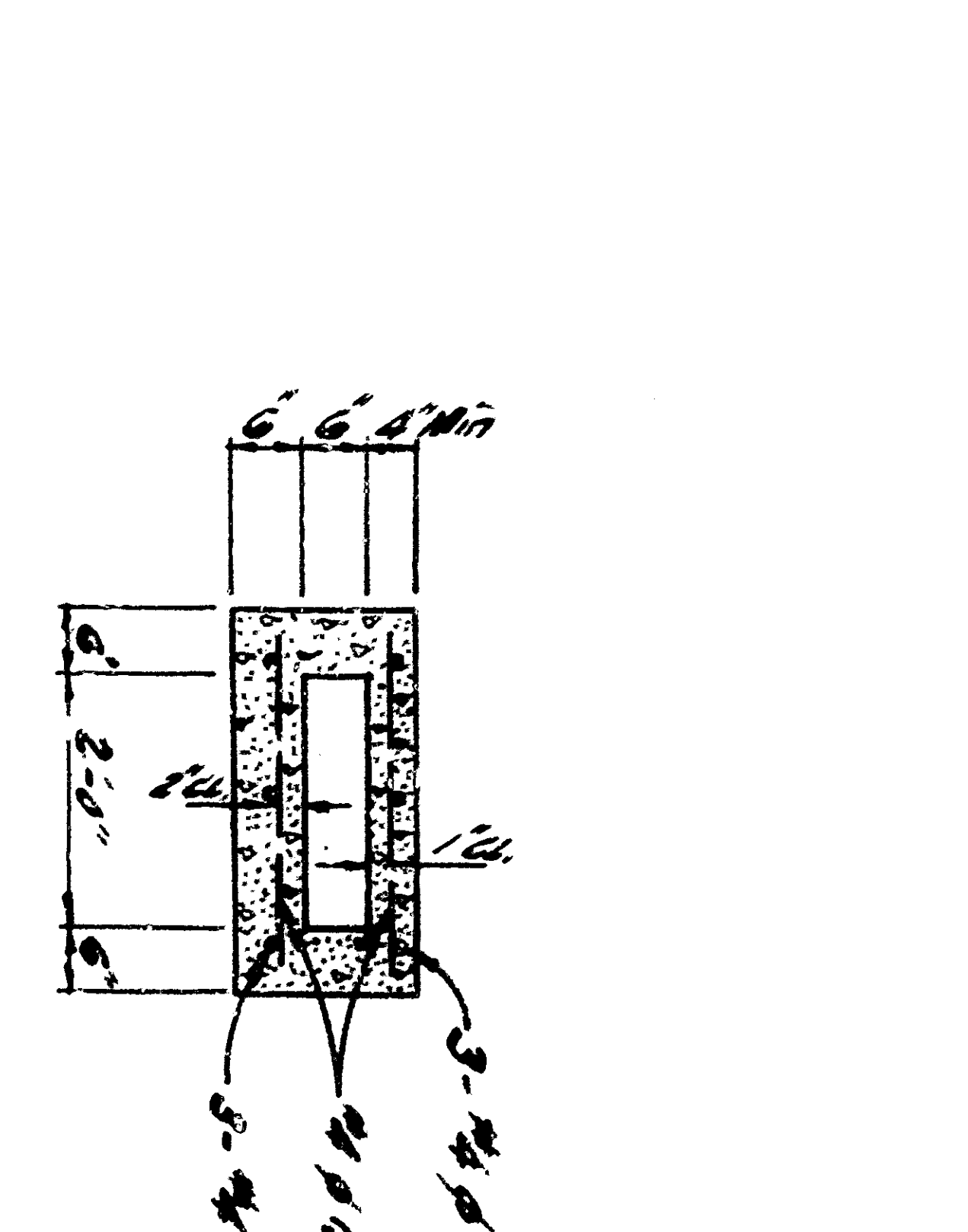
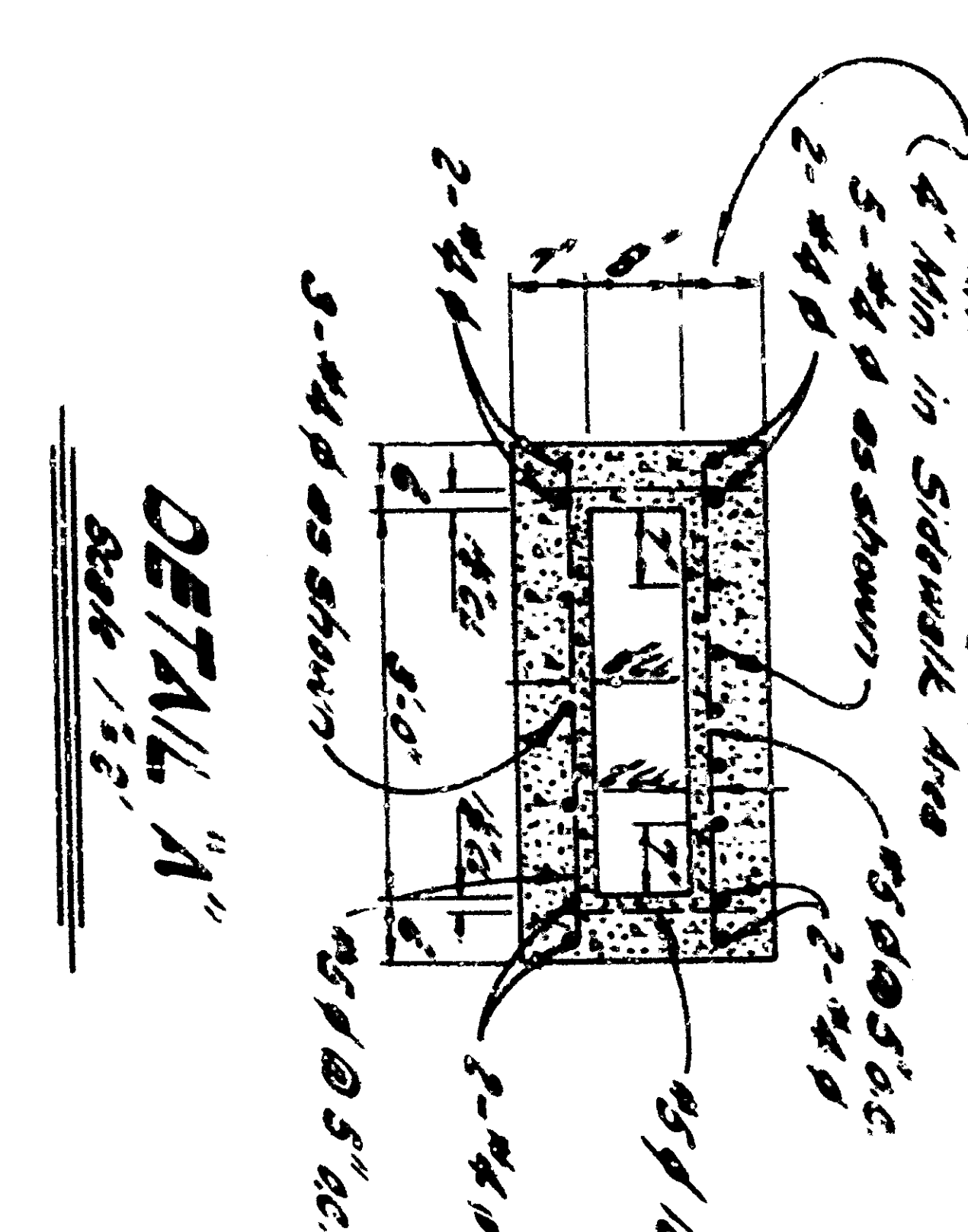
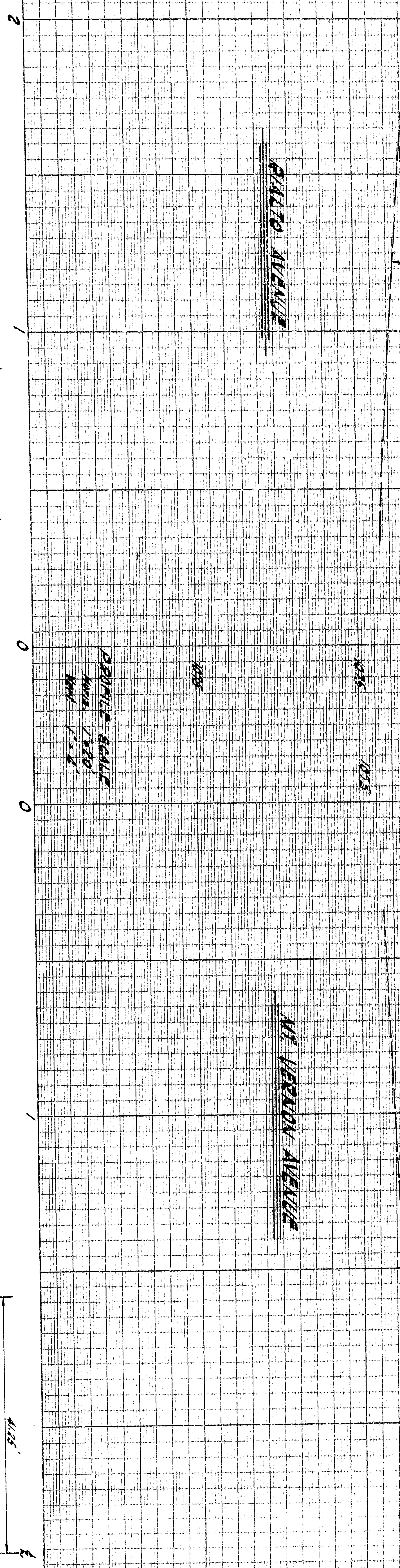
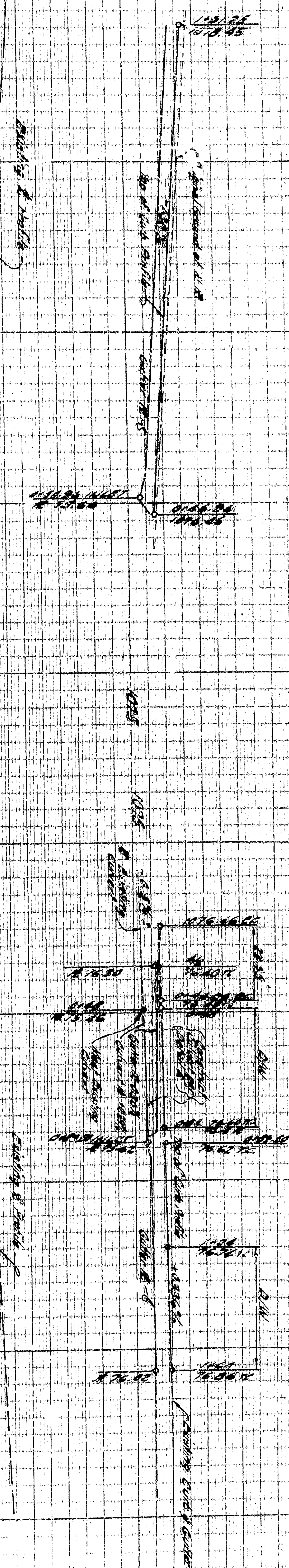

**APPROVED**  
 RIDDLE STRAIN HOZELING  
 SHEET 1 OF 1  
 CITY OF SAN BERNARDINO  
 DEPARTMENT OF ENGINEERING  
 IMPROVEMENT OF THE LHM CURB AND GUTTER  
 RIALTO AVENUE & MT VERNON AVENUE